



US006202169B1

(12) **United States Patent**
Razzaghe-Ashrafi et al.

(10) **Patent No.:** **US 6,202,169 B1**
(45) **Date of Patent:** **Mar. 13, 2001**

- (54) **TRANSITIONING BETWEEN REDUNDANT COMPUTER SYSTEMS ON A NETWORK**
- (75) Inventors: **Siamak Razzaghe-Ashrafi; Denny D. Landaveri**, both of Santa Clara, CA (US)
- (73) Assignee: **Nortel Networks Corporation**, Montreal (CA)
- (*) Notice: Subject to any disclaimer, the term of this patent is extended or adjusted under 35 U.S.C. 154(b) by 0 days.

David C. Plummer, "An Ethernet Address Resolution Protocol" or "Converting Network Protocol Addresses to 48.bit Ethernet Address for Transmission on Ethernet Hardware", Nov., 1982, 10 pages.
 Schuba et al., "Classical IP and ARP over ATM", 24 pages.
 * cited by examiner

Primary Examiner—Thomas C. Lee
Assistant Examiner—Nitin Patel
 (74) *Attorney, Agent, or Firm*—Blakely, Sokoloff, Taylor & Zafman LLP

- (21) Appl. No.: **09/001,544**
- (22) Filed: **Dec. 31, 1997**
- (51) **Int. Cl.**⁷ **H02H 3/05; H03K 19/003**
- (52) **U.S. Cl.** **714/6; 714/1**
- (58) **Field of Search** 709/203, 221, 709/220, 245, 300, 304, 223, 228, 243; 714/4, 10, 11, 6

(57) **ABSTRACT**

A method is provided for transitioning between redundant computer systems on a network. According to one aspect of the present invention, fault tolerance may be achieved in a network which includes one or more redundant computer systems by monitoring the status of a primary system and having a redundant system take over for the primary system upon determining the primary system has entered a predetermined state (e.g., lost power, CPU has gone down, etc.). Each host machine on the network includes an address translation table (e.g., an Address Resolution Protocol (ARP) cache) for purposes of dynamically mapping a logical address (e.g., an Internet Protocol (IP) address) to a physical address (e.g., a MAC address). Therefore, transitioning from the primary system to a redundant system that shares the same logical address may be accomplished by simply transmitting an ARP reply containing therein the shared logical address and the physical address of the redundant system or an ARP proxy server with which the redundant system is registered. In this manner, the host machines will update their address translation tables such that the shared logical address will be associated with the physical address provided in the ARP reply and further transmissions addressed to the shared logical address will in effect be redirected to the redundant system either directly or indirectly through the ARP proxy server.

- (56) **References Cited**
- U.S. PATENT DOCUMENTS**
- 5,696,895 * 12/1997 Hemphill et al. 395/182.02
- 5,790,541 * 8/1998 Patrick et al. 370/392
- 5,812,751 * 9/1998 Ekrot et al. 395/182
- 5,917,997 * 6/1999 Bell et al. 395/182.02
- 5,923,840 * 7/1999 Desnoyers et al. 395/185
- 5,936,936 * 8/1999 Alexander, Jr. et al. 370/216

OTHER PUBLICATIONS

HolonTech Corporation, "The HyperFlow Architecture for all/IP Web Server Clustering", Feb., 1998, 12 pages.

17 Claims, 6 Drawing Sheets

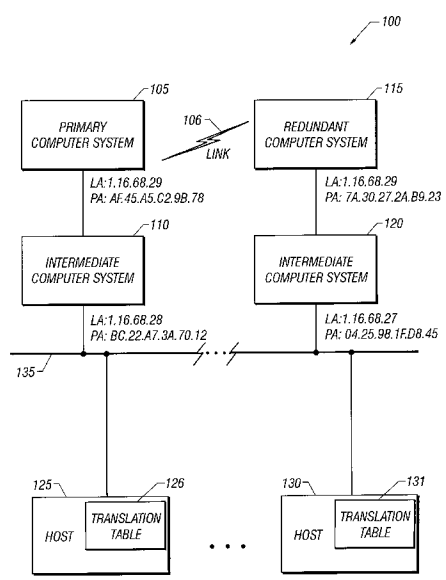

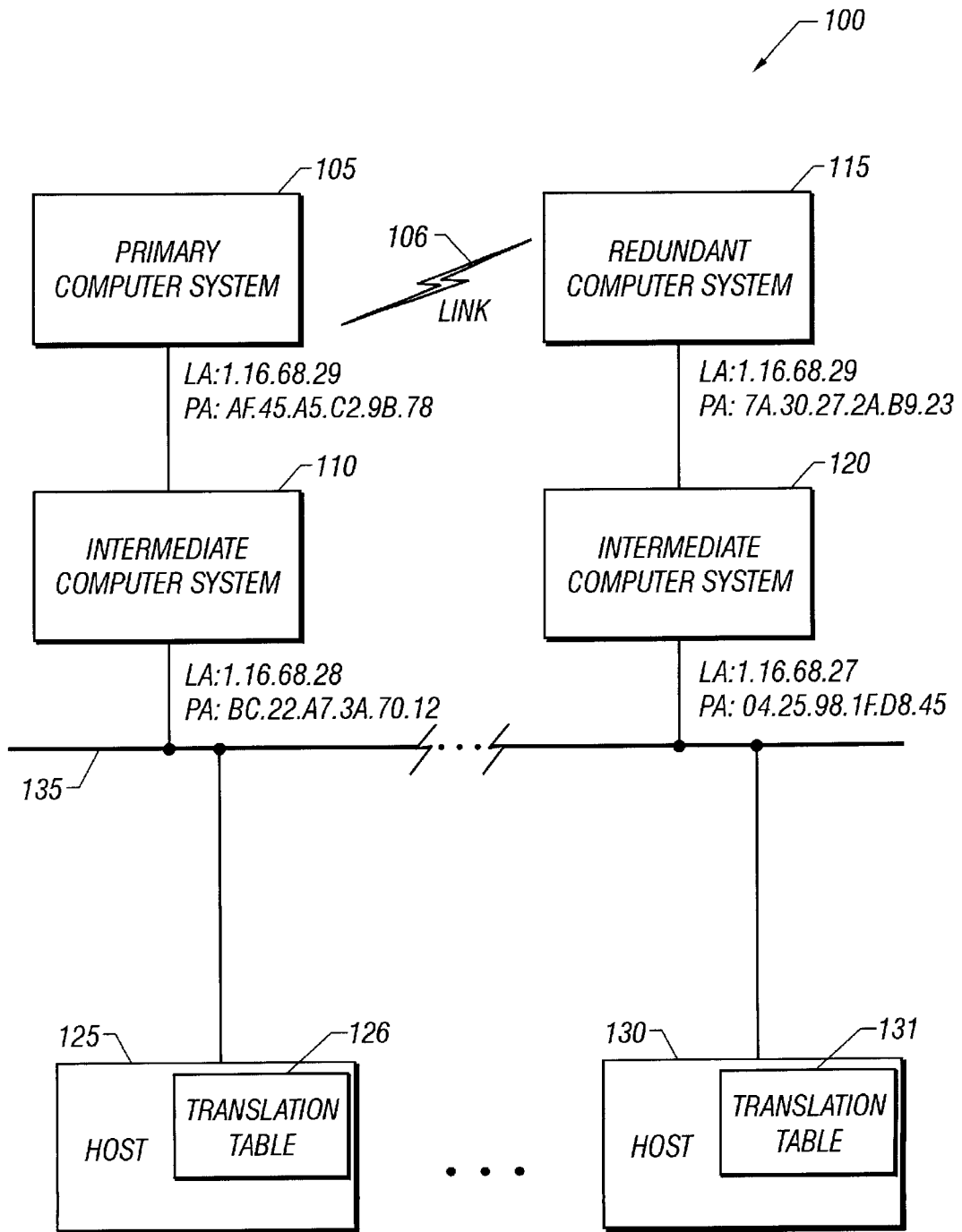

FIG. 1A

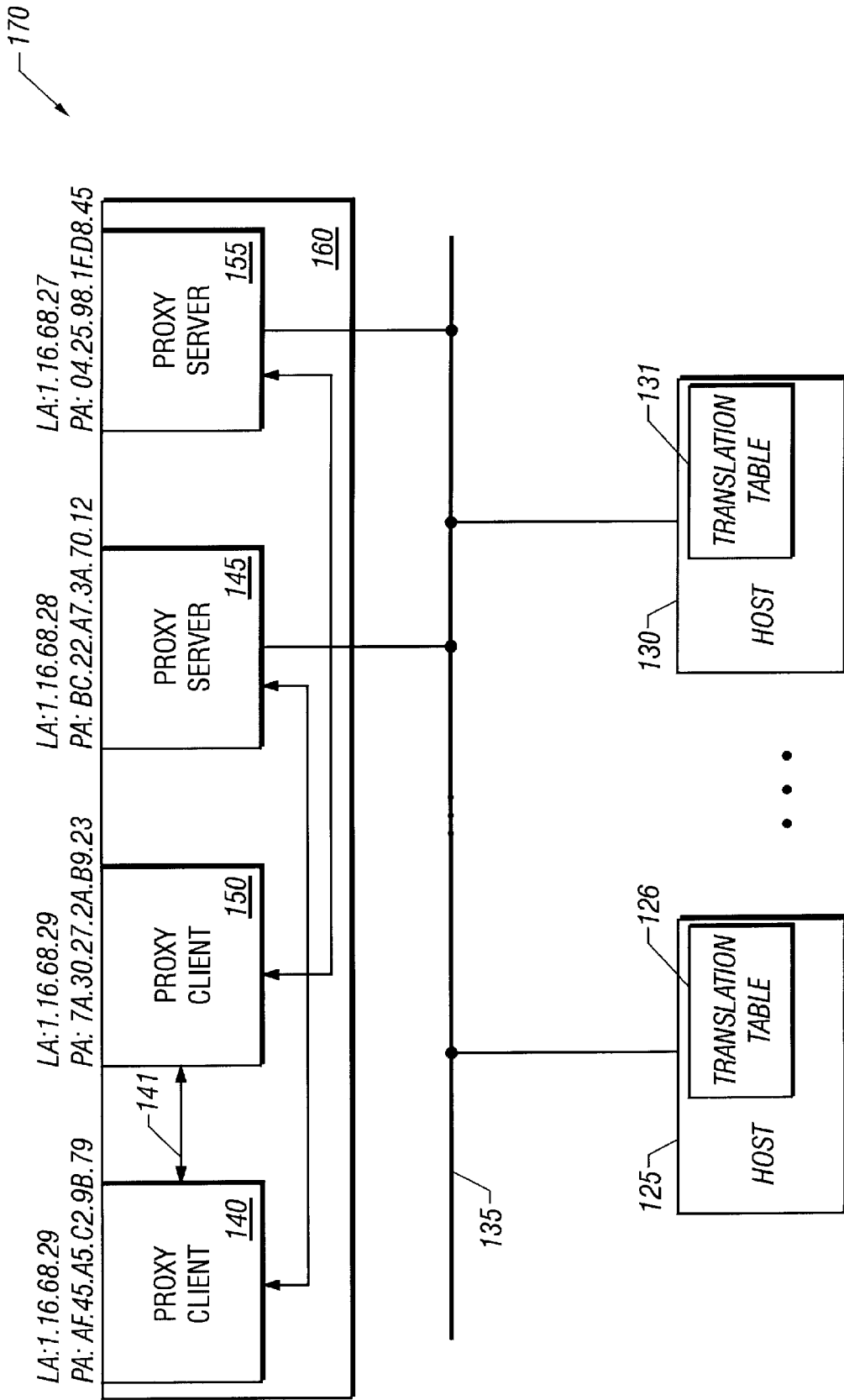



FIG. 1B

TRANSLATION TABLE



...	...
1.16.68.29	AF.45.A5.C2.9B.78
...	...

FIG. 2A

TRANSLATION TABLE



...	...
1.16.68.29	7A.30.27.2A.B9.23
...	...

FIG. 2B

TRANSLATION TABLE



...	...
1.16.68.29	BC.22.A7.3A.70.12
...	...

FIG. 3A

TRANSLATION TABLE



...	...
1.16.68.29	04.25.98.1F.D8.45
...	...

FIG. 3B

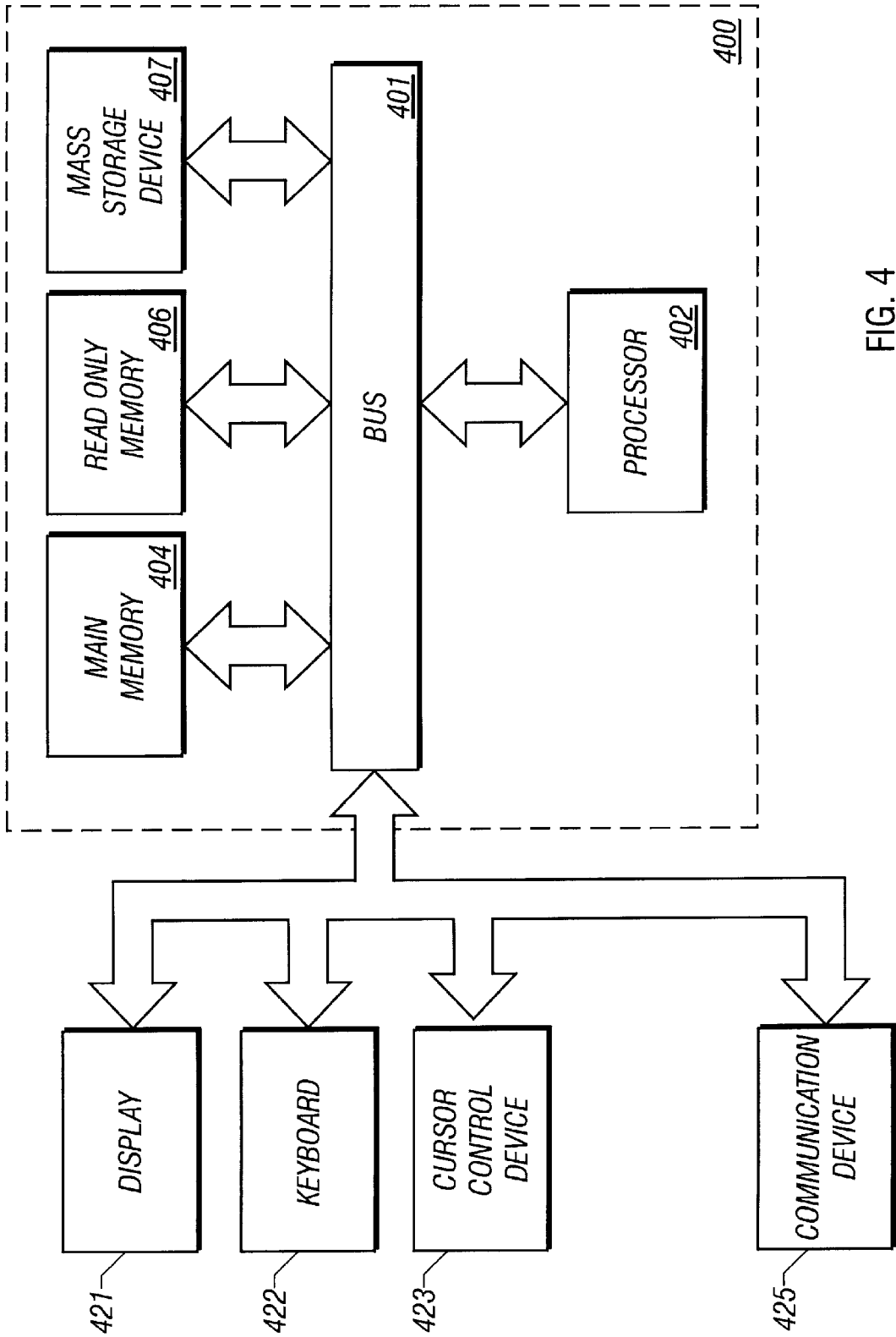

FIG. 4

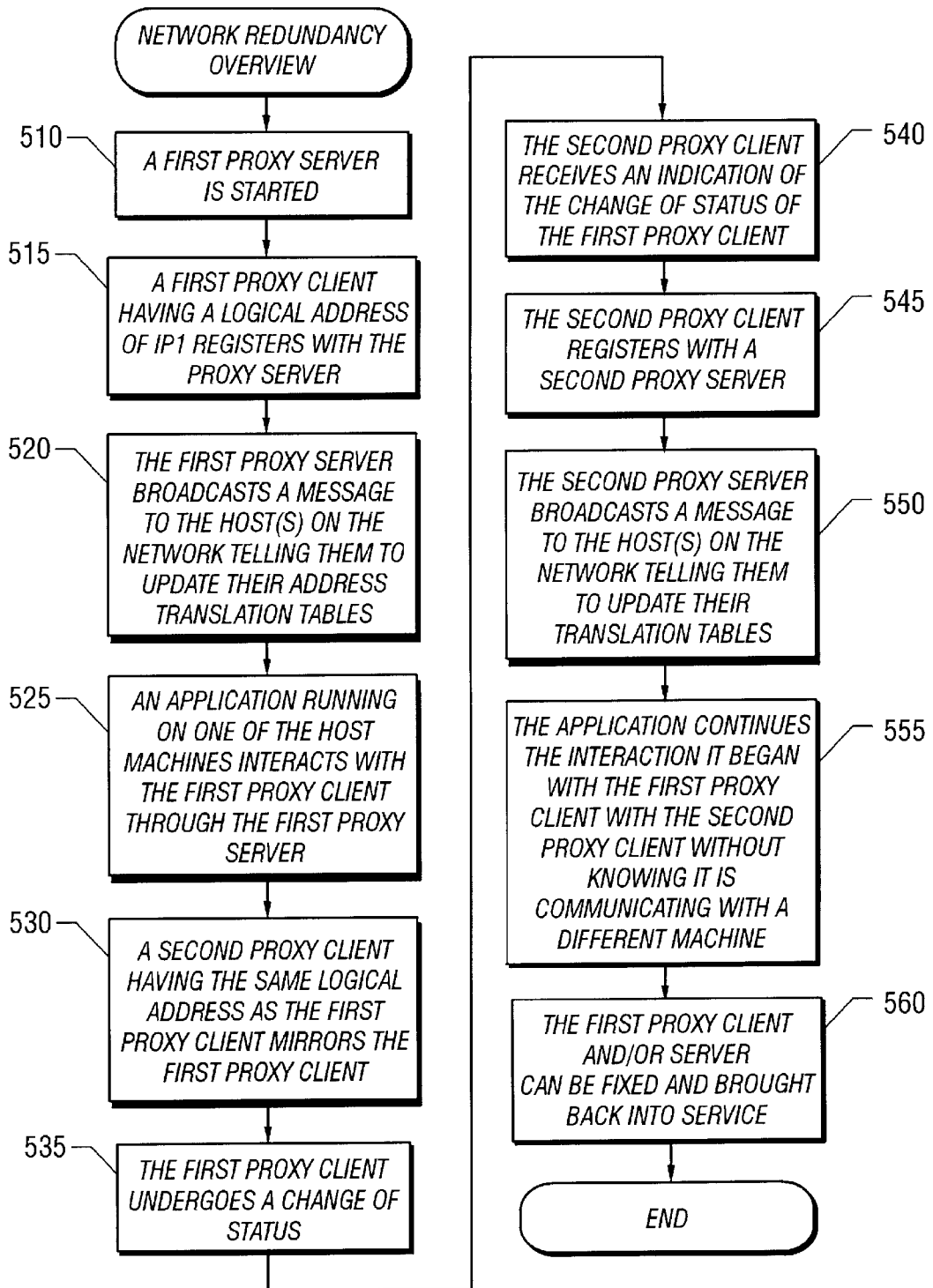

FIG. 5

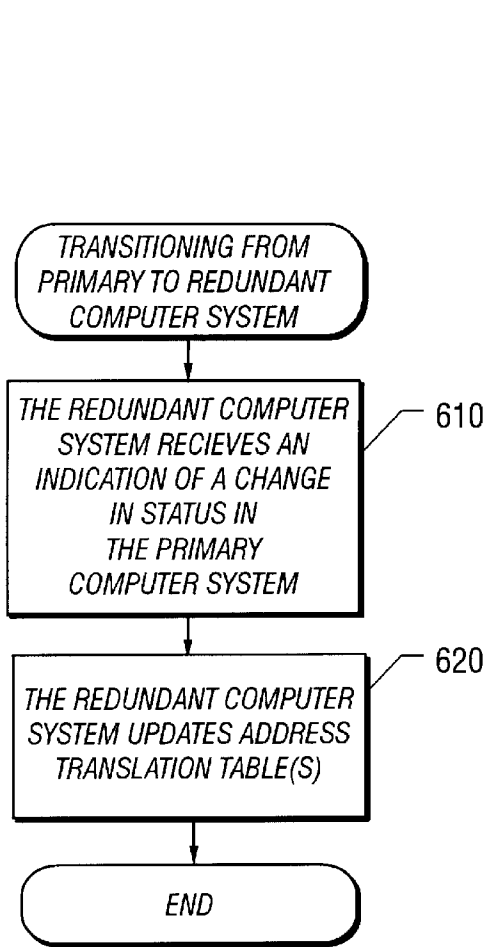

FIG. 6

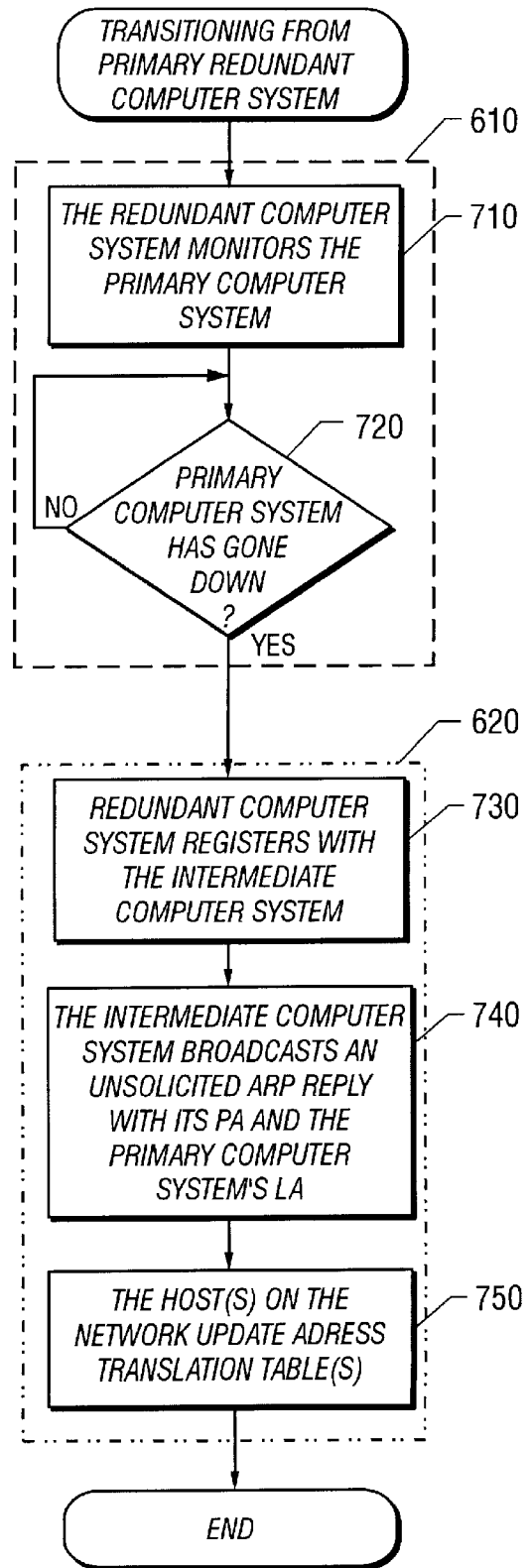

FIG. 7

TRANSITIONING BETWEEN REDUNDANT COMPUTER SYSTEMS ON A NETWORK

FIELD OF THE INVENTION

The invention relates generally to the field of computer networking. More particularly, the invention relates to a mechanism for allowing a redundant computer system to take over for a primary computer system upon the happening of a predetermined event.

BACKGROUND OF THE INVENTION

Often in a networking environment it is advantageous to have redundant resources. For example, redundancy may be used to increase the fault tolerance of a network. One of the difficulties of taking advantage of redundant computer systems, however, lies in transitioning from one computer system to the other with minimal disruption on the software applications that may be using resources associated with the primary computer system. For instance, upon such a transition, to assure network traffic destined for a primary computer system is, instead, sent to a redundant computer system, one approach would be to move the addresses associated with the primary computer system to the redundant computer system. This involves moving the primary computer system's logical address (e.g., an Internet Protocol (IP) address) and the hardware or physical address (e.g., an Ethernet address) embedded in the primary computer system's communication device to the redundant computer system. However, since hardware addresses are typically assigned and burned into communication devices by the manufacturer, they are usually thought of as fixed. Therefore, an approach that requires a hardware address to be moved from one communication device to another is quite unnatural.

In addition, third-party software applications, provided by Microsoft and other software vendors, would require modification to handle this redundancy scheme. Applications would have to be altered to react appropriately during a transition from one computer system to another. For example, upon detecting such a transition, the applications might need to be configured to store their current state, terminate existing connections with the primary computer system, re-establish the appropriate connections with the redundant computer system, and then resume processing with the redundant computer system at the stored state. It should be appreciated that an approach to network redundancy involving rewriting third-party software applications is neither desirable nor directly available to designers and manufacturers of networking equipment, as such an approach would likely require the consent and cooperation of many different software vendors.

In view of the foregoing, what is needed is an elegant mechanism for transitioning between redundant computer systems. Specifically, it would be advantageous to perform the transition without having to perform the awkward step of moving a hardware address from one communication device to another. Ideally, the transition should also be transparent to software applications that may have been communicating with the primary computer system prior to the transition.

SUMMARY OF THE INVENTION

A method is described for transitioning between redundant computer systems on a network. The redundant computer system receives an indication of a change in status of a primary computer system. In response to the change in

status, the redundant computer system causes an entry in an address translation table on a third computer system to be updated. By employing this simple, elegant mechanism for transitioning between redundant computer systems hardware addresses need not be moved from one communication device to another and the transition is transparent to software applications that are communicating with the primary computer system during the transition.

According to one aspect of the present invention, prior to being updated the entry maps a first logical address associated with the primary computer system to a first physical address and after the update then entry maps the first logical address to a second physical address.

According to another aspect of the present invention, the redundant computer system causes the entry in the address translation table to be updated by causing an unsolicited Address Resolution Protocol (ARP) reply to be transmitted to the third computer system.

According to yet another aspect of the present invention, the redundant computer system is coupled to the network through a first ARP proxy server and the primary computer system is coupled to the network through a second ARP proxy server.

Other features of the present invention will be apparent from the accompanying drawings and from the detailed description which follows.

BRIEF DESCRIPTION OF THE DRAWINGS

The present invention is illustrated by way of example, and not by way of limitation, in the figures of the accompanying drawings and in which like reference numerals refer to similar elements and in which:

FIG. 1A is a block diagram illustrating a network with redundant computer systems in which one embodiment of the present invention may be employed.

FIG. 1B is a block diagram illustrating network redundancy according to another embodiment of the present invention.

FIG. 2A illustrates an address translation table in an initial state.

FIG. 2B illustrates the address translation table of FIG. 2A after it has been updated according to one embodiment of the present invention.

FIG. 3A illustrates an address translation table in an initial state.

FIG. 3B illustrates the address translation table of FIG. 3A after it has been updated according to one embodiment of the present invention.

FIG. 4 is an example of a typical computer system upon which one embodiment of the present invention may be implemented.

FIG. 5 is a flow diagram illustrating high level network redundancy processing according to one embodiment of the present invention.

FIG. 6 is a flow diagram illustrating the processing involved in transitioning from a primary computer system to a redundant computer system according to one embodiment of the present invention.

FIG. 7 is a flow diagram illustrating the processing involved in transitioning from a primary computer system to a redundant computer system according to another embodiment of the present invention.

DETAILED DESCRIPTION

A method of transitioning between redundant computer systems is described. According to various embodiments of

the present invention, fault tolerance may be achieved in a network which includes one or more redundant computer systems by monitoring the status of a primary computer system and having a redundant computer system take over for the primary computer system upon determining the primary computer system has gone down. Each host machine on the network includes an address translation table for purposes of mapping a logical address to a physical address. Therefore, an elegant transition from a primary computer system to a redundant computer system that shares the same logical address may be accomplished by simply updating the address translation tables. After having received a physical address in response to an address resolution request corresponding to the logical address of the primary computer system, the address translation tables associate the primary computer's logical address with the primary computer's physical address or the physical address of an associated proxy server. After the address translation tables are updated for purposes of transitioning from the primary computer to the redundant computer, however; the logical address becomes associated with the physical address of the redundant computer system or the physical address of a proxy server with which the redundant computer system is registered. Importantly, the address translation tables are accessed by protocol layers located below the application layer in the protocol stack. As a result, applications running on the host machines are not disturbed by changes to these tables. Advantageously, in this manner, a seamless transition may be made from one computer system to another without the trouble of modifying the standard applications that run on the host machines.

In the following description, for the purposes of explanation, numerous specific details are set forth in order to provide a thorough understanding of the present invention. It will be apparent, however, to one skilled in the art that the present invention may be practiced without some of these specific details. In other instances, well-known structures and devices are shown in block diagram form.

The present invention includes various steps, which will be described below. The steps of the present invention may be embodied in machine-executable instructions. The instructions can be used to cause a general-purpose or special-purpose processor that is programmed with the instructions to perform the steps of the present invention. Alternatively, the steps of the present invention may be performed by specific hardware components that contain hardwired logic for performing the steps, or by any combination of programmed computer components and custom hardware components. While, embodiments of the present invention will be described with reference to an Ethernet network and a specific address resolution protocol, the method described herein is equally applicable to other types of networks and address resolution schemes.

ADDRESS RESOLUTION

As this disclosure is written for those of ordinary skill in the art, familiarity with address resolution schemes such as the Address Resolution Protocol (ARP) is assumed. For a detailed discussion of ARP see Request For Comments (RFC) 826 entitled "An Ethernet Address Resolution Protocol" by David C. Plummer, November 1982, which describes a protocol that allows dynamic distribution of information needed to convert Protocol Addresses (e.g., logical addresses or Internet Protocol (IP) addresses) to Local Network Addresses (e.g., physical addresses or Ethernet addresses).

EXEMPLARY REDUNDANT NETWORKS

Referring now to FIG. 1A, an exemplary network 100 with redundant computer systems 105, 110, 115, and 120 is

briefly described in which one embodiment of the present invention may be employed. In the embodiment depicted, the network 100 includes primary computer system 105, redundant computer system 115, and optional intermediate computer systems 110, 120. The network 100 may be a simple Local Area Network (LAN), a company's Intranet comprising many interconnected LANs, or the network 100 may represent the Internet. Due in part to the optional nature of the intermediate computer systems 110, 120, it should be appreciated that in alternative embodiments, more or less computer systems may be part of the network 100.

In any event, the primary computer system 105 may be coupled to communication medium 135 directly or optionally it may be coupled to the communication medium 135 via intermediate computer system 110. The intermediate computer system 110 may act as an Address Resolution Protocol (ARP) proxy server for the primary computer system 105 by responding to ARP requests for the physical address of the primary computer system 105 with ARP replies containing the physical address of the intermediate computer system 110. When the optional intermediate computer system 110 is present it routes messages (e.g., EP packets) addressed to the primary computer system's logical address to the primary computer system 105.

The redundant computer system 115 may also be directly coupled to the communication medium 135 or coupled indirectly through optional intermediate computer system 120. In the latter case, the intermediate computer system 120 may proxy ARP for the redundant computer system 115. That is, the intermediate computer system 120 may respond on behalf of the redundant computer system 115 to ARP requests for the redundant computer system's physical address. When the optional intermediate computer system 120 is present it routes messages (e.g., IP packets) addressed to the redundant computer system's logical address to the primary computer system 105.

A link 106 may optionally allow the primary computer system 105 and the redundant computer system 115 to communicate directly. The link 106 may be a physical link, such as a CMB cable, a wireless link, or other communication medium. In any event, the link 106 may be used by the redundant computer system 115 to monitor the status of the primary computer system 105.

Additionally, link 106 may be used to allow the redundant computer system 115 to "mirror" the primary computer system 105 as will be discussed further below. In this manner, the redundant computer system 115 would be able to take over for the primary computer system 105 should the primary computer system 105 experience a failure (e.g., crash, loss of power, etc.).

The network 100 also includes host machines 125, 130. Applications running on the host machines 125, 130 may depend upon various resources and/or services provided by primary computer system 105. Host machine 125 and host machine 130 each further include an address translation table (also referred to as an "ARP cache") 126 and 131, respectively. The address translation tables 126, 131 maintain mappings between logical addresses (e.g., IP addresses) and their corresponding physical addresses (e.g., Media Access Control (MAC) addresses).

FIG. 1B is a block diagram illustrating network redundancy according to another embodiment of the present invention. In this embodiment, a network 170 comprises host machines 125, 130, described above, and a redundant, chassis-based system 160 coupled to communication medium 135. The chassis 160 includes four cards, in this

example, two proxy client cards **140**, **150** and two proxy server cards **145**, **155**. In one embodiment, proxy server **155** may act as an ARP proxy server for proxy client **150** and proxy server **145** may act as an ARP proxy server for proxy client **140**. As above, a link **141** may provide the redundant client **140** or **150** with the ability to monitor and mirror the primary client **140** or **150**.

ADDRESS TRANSLATION TABLE MODIFICATION

When one of the redundant computer systems undergoes a change in status, such as a failure, a crash, a loss of power, or the like, it is desirable for network traffic destined for the computer system that has gone down to be redirected to another computer system in a manner that is transparent to the software applications that may be generating the network traffic.

Disregarding conventional wisdom which suggests address resolution replies should be sent only by the target computer system and only in response to an address resolution query, the assignee of the present invention has discovered that existing address resolution schemes, such as ARP or the like, may be employed to redirect network traffic from one computer to another in a manner that is transparent to software applications that may be communicating with the computer at the time of transition. Rather than transmitting an address resolution reply (e.g., an ARP reply) from the target system in response to an address resolution query (e.g., an ARP query), according to embodiments of the present invention, a system other than the target system may generate and broadcast an unsolicited address resolution reply to all hosts on the network upon detecting the target system has undergone a predetermined change in status. Importantly, because the logical address of the redundant computer systems is the same, all that needs to be changed is the physical address currently bound to the logical address. This binding is changed by way of an unsolicited address resolution reply which instructs devices on the network to replace the current physical address associated with the logical address of the failed computer system with the physical address of the redundant computer system or a proxy server associated with the redundant computer system as will be illustrated below.

FIG. 2A illustrates a simplified address translation table **126** in an initial state after the host **125** has learned the physical address of the primary computer system **105**, for example.

Assuming the status of the primary computer system **105** has changed and the change in status was detected by the redundant computer system **115**, FIG. 2B illustrates the address translation table **126** of FIG. 2A after the address translation table **126** has been updated to contain the physical address of the redundant computer system **115**. For example, the update may have been caused by host **125** receiving an unsolicited address resolution reply from the redundant computer system **115** containing the physical address of the redundant computer system **115**. In this manner, subsequent attempts by host **125** to send a message (e.g., an IP packet) to the primary computer system **105** will result instead in a message being transmitted to the physical address of the redundant computer system **115** without the application software running on the host **125** realizing the difference or being impacted by the transition.

FIG. 3A illustrates a simplified address translation table **126** in an initial state after the host **125** has learned that the physical address to be bound to the primary computer system's logical address is the physical address of the

intermediate computer system **110** (e.g., an ARP proxy server, router, or the like), for example.

Assuming the status of the primary computer system **105** has changed and the change in status was detected by the redundant computer system **115**, FIG. 3B illustrates the address translation table **126** of FIG. 3A after the address translation table **126** has been updated to contain the physical address of the intermediate computer system **120** (e.g., an ARP proxy server, router, or the like). According to one embodiment of the present invention, the update to this particular entry in the address translation table **126** of host **125** may be caused by the host **125** receiving an unsolicited address resolution reply from the intermediate computer system **120** containing the physical address of the intermediate computer system **120** and the shared logical address. In this manner, subsequent attempts by host **125** to send a message (e.g., an IP packet) to the primary computer system **105** will result instead in a message being transmitted to the physical address of the intermediate computer system **120** which will in turn forward the message to the redundant computer system **115**. Again, this transition from the primary computer system **105** to the redundant computer system **115** is accomplished without the application software running on the host **125** realizing the difference, being impacted by the transition, and without the software being rewritten.

AN EXEMPLARY COMPUTER SYSTEM

A computer system **400** representing an exemplary intermediate computer system **110**, **120** or primary or redundant computer system **105**, **115** in which features of the present invention may be implemented will now be described with reference to FIG. 4. Computer system **400** comprises a bus or other communication means **401** for communicating information, and a processing means such as processor **402** coupled with bus **401** for processing information. Computer system **400** further comprises a random access memory (RAM) or other dynamic storage device **404** (referred to as main memory), coupled to bus **401** for storing information and instructions to be executed by processor **402**. Main memory **404** also may be used for storing temporary variables or other intermediate information during execution of instructions by processor **402**. Computer system **400** also comprises a read only memory (ROM) and/or other static storage device **406** coupled to bus **401** for storing static information and instructions for processor **402**.

A data storage device **407** such as a magnetic disk or optical disc and its corresponding drive may also be coupled to computer system **400** for storing information and instructions. Computer system **400** may also be coupled via bus **401** to a display device **421**, such as a cathode ray tube (CRT) or Liquid Crystal Display (LCD), for displaying information to a computer user. Typically, in the case of a host machine **125**, **130**, an alphanumeric input device **422**, including alphanumeric and other keys, may be coupled to bus **401** for communicating information and/or command selections to processor **402**. Another type of user input device is cursor control **423**, such as a mouse, a trackball, or cursor direction keys for communicating direction information and command selections to processor **402** and for controlling cursor movement on display **421**.

A communication device **425** may also be coupled to bus **401** for communicating with other computer systems on the network **100** or accessing remote servers, such as primary computer system **105** or redundant computer system **115**, or other servers via the Internet, for example. The communi-

cation device **425** may include a modem, a network interface card, or other well known interface devices, such as those used for coupling to Ethernet, token ring, ATM, or other type of network. In any event, in this manner, the computer system **400** may be coupled to a number of clients and/or servers via a conventional network infrastructure, such as a company's Intranet and/or the Internet, for example.

While for simplicity, the computer systems of FIGS. **1A** and **1B** have been described as general desktop machines or workstations, it should be appreciated that the redundant computer systems may be one of many private branch exchange (PBX) systems manufactured and sold by Northern Telecom, the assignee of the present invention, such as the Meridian **1** product line. Further, in various embodiments of the present invention the host machines **125, 130** may employ Meridian Administration Tools developed by the assignee of the present invention, such as MAT Release **5** which supports communication to the Meridian **1** through the use of TCP/IP over Ethernet or the use of PPP for serial connections. In this manner, users stationed at the host machines **125, 130** may receive detailed information regarding stations administration, traffic analysis, call accounting, call tracking, alarm management, etc.

NETWORK REDUNDANCY OVERVIEW

Having described exemplary environments in which the present invention may be employed, a high level overview of the network redundancy processing according to one embodiment of the present invention will now be described with reference to FIG. **5**. The steps described below may be performed under the control of a programmed processor, such as processor **402**. At step **510**, a first proxy server **145** (the primary system) is started. In this example, at step **515**, a first proxy client **140** registers with the first proxy server **145**. At step **520**, the first proxy server **145** broadcasts a message (e.g., an ARP reply or the like) to the hosts **125, 130** on the network **170** telling them to update their address translation tables **126, 131** with the first proxy server's physical address (e.g., MAC address) for purposes of sending packets to the shared logical address. At step **525**, an application running on one of the host machines **125, 130** interacts with the first proxy client **140** through the first proxy server **145**.

In the present embodiment, at step **530**, a second proxy client **150** having the same logical address as the first proxy client **140** may mirror the first proxy client **140**. By mirroring what is meant is: (1) shadowing the memory of the first proxy client **140** within a memory of the second proxy client **150** while the processor of the second proxy client **150** remains idle, (2) concurrently running the same tasks, programs, etc. on both clients **140, 150**, or (3) other mechanism for providing the current state of the first proxy client **140** to the second proxy client **150** so as to allow the redundant system to continue processing where the primary system left off. For example, certain values from registers in the central processing unit of the primary system may be transferred to the redundant system, such as the program counter (PC) which contains the address of the next instruction to be executed in the program sequence.

At step **535** the first proxy client **140** undergoes a change of status. For example, the power may have gone down, the processor may have crashed, or some other system fault may have occurred. Those of ordinary skill in the art will be aware of various other changes in status that may warrant transitioning to the second proxy client **150**. In any event, at step **540**, the second proxy client **150** receives an indication

of the change of status of the first proxy client **140**. The indication may be received over link **141** or from the network **175** via proxy server **155**, for example.

Responsive to the change of status of the first proxy client **140**, the second proxy client **150** registers with a second proxy server **155** (step **545**). The second proxy server **155** then broadcasts a message (e.g., an ARP reply or the like) to the hosts **125, 130** on the network **170** telling them to update their address translation tables **126, 131** with the second proxy server's physical address for purposes of sending packets to the shared logical address (step **550**). In this manner, subsequent packets sent by hosts **125, 130** will be routed to the second proxy client **150** via the second proxy server **155**.

Importantly, at this point, the first proxy server **145** should no longer respond to address resolution requests for the logical address shared by the first proxy client **140** and the second proxy client **150**. Once the second proxy client **150** has taken over for the first proxy client **140**, only the second proxy server **155** should proxy ARP for the logical address shared by the two proxy clients **140, 150**. In this manner, confusion regarding the correct physical address to be bound with the shared logical address will be avoided.

At step **555**, the application continues the interaction that was begun at step **525**. However, the application is now unknowingly communicating with a different system, namely the second proxy client **145** via the second proxy server **155**. At this point, the first proxy client **140** and/or the first proxy server **150** may be repaired and brought back into service.

TRANSITIONING FROM A PRIMARY COMPUTER SYSTEM TO A REDUNDANT COMPUTER SYSTEM

Exemplary mechanisms for transitioning between redundant computer systems will now be described. FIG. **6** is a flow diagram illustrating the processing involved in transitioning from a primary computer system to a redundant computer system according to one embodiment of the present invention. In this embodiment, at step **610**, the redundant computer system **115** receives an indication of a change in status in the primary computer system **105**. Again this indication may be via the link **106** or by way of the network **100**. In any event, at step **620**, the redundant computer system **115** causes the address translation tables **126, 131** on the network to be updated thereby causing subsequent packets destined for the logical address shared by the two computer systems **105, 115** to be routed to the redundant computer system **115** either directly or indirectly through the intermediate computer system **120**.

FIG. **7** is a flow diagram illustrating the processing involved in transitioning from a primary computer system to a redundant computer system according to another embodiment of the present invention. According to the embodiment depicted, step **610** further comprises steps **710** and **720**. At step **710**, the redundant computer system **115** monitors the primary computer system **105**. If the primary computer system **105** has gone down at step **720** then processing proceeds to step **730**; otherwise the redundant computer system **115** continues to test for a change in status of the primary computer system **105**.

According to this embodiment, step **620** further comprises steps **730** though **750**. At step **730** the redundant computer system **115** registers with the intermediate computer system **120**. Importantly, since the redundant computer system **115** and the primary computer system **105** share the same logical address, only one should be active on the network **100** at a time.

At step **740**, the intermediate computer system **120** broadcasts an unsolicited ARP reply including the physical address of the intermediate computer system **120** and the logical address shared by the primary computer system **105** and the redundant computer system **115**. Responsive to receipt of the broadcast ARP reply, at step **750**, each host on the network that receives the ARP reply updates its address translation table to map the shared logical address to the physical address of the intermediate computer system **120**.

ALTERNATIVE EMBODIMENTS

Many alternative embodiments are contemplated by the assignee of the present invention. For example, it is envisioned that aspects of the present invention may be a valuable addition to the World Wide Web (“the Web”). By way of illustration, redundant groups of HyperText Transfer Protocol (HTTP) servers may reside behind ARP proxy servers, when one or more of the HTTP servers in one group crash, the other group may take over by causing address resolution replies to be broadcast throughout the network. In this manner, both the number of lost hits and the perceived downtime can be minimized.

In the foregoing specification, the invention has been described with reference to specific embodiments thereof. It will, however, be evident that various modifications and changes may be made thereto without departing from the broader spirit and scope of the invention. The specification and drawings are, accordingly, to be regarded in an illustrative rather than a restrictive sense.

What is claimed is:

1. A method comprising:

a redundant computer system receiving an indication of a change in status of a primary computer system, the redundant computer system coupled to the network through a first intermediate computer system which acts as an ARP proxy server for the redundant computer system; and

responsive to the change in status, the redundant computer system updating an entry in an address translation table on a third computer system by causing the first intermediate computer system to transmit an unsolicited ARP reply to the third computer, wherein prior to being updated the entry mapping a first logical address associated with the primary computer system to a first physical address, after being updated the entry mapping the first logical address to a second physical address.

2. The method of claim **1**, wherein the primary computer system is coupled to the network through a second intermediate computer system which acts as an ARP proxy server for the primary computer system, and wherein the first physical address is associated with the second intermediate computer system and the second physical address is associated with the first intermediate computer system.

3. The method of claim **2**, wherein the first and second physical addresses comprise Ethernet addresses.

4. The method of claim **1**, wherein the unsolicited ARP reply indicates the first logical address maps to the second physical address.

5. The method of claim **4**, wherein the first and second logical addresses comprise the same IP addresses.

6. A method comprising:

providing a first and a second proxy client having a shared Internet Protocol (IP) address;

providing a first proxy server corresponding to the first proxy client, the first proxy server having a first physical address associated therewith;

providing a second proxy server corresponding to the second proxy client, the second proxy server having a second physical address associated therewith;

the first proxy client registering as a client of the first proxy server;

the first proxy server broadcasting onto the network an unsolicited Address Resolution Protocol (ARP) reply, in response to said registering, containing the shared IP address and the first physical address;

the second proxy client monitoring a status associated with the first proxy client; and

if the first proxy client enters a predetermined state, then the second proxy client taking over for the first proxy client by registering as a client of the second proxy server, and causing the second proxy server to broadcast onto the network an unsolicited ARP reply containing the shared IP address and the second physical address.

7. A machine-readable medium having stored thereon data representing sequences of instructions, said sequences of instructions which, when executed by a processor of a secondary computer system on a network, cause said processor to:

detect a change in status of a primary computer system on the network; and

update an entry in an address translation table on a third computer system on the network by causing a first intermediate computer system that couples the secondary computer system to the network to transmit an unsolicited ARP reply to the third computer.

8. The machine-readable medium of claim **7**, wherein prior to being updated the entry mapping a first logical address associated with the primary computer system to a first physical address, after being updated the entry mapping the first logical address to a second physical address.

9. The machine-readable medium of claim **8**, wherein the primary computer system is coupled to the network through a second intermediate computer system which acts as an ARP proxy server for the primary computer system, and wherein the first physical address is associated with the second intermediate computer system and the second physical address is associated with the first intermediate computer system.

10. The machine-readable medium of claim **9**, wherein the first and second physical addresses comprise Ethernet addresses.

11. The machine-readable medium of claim **8**, wherein the unsolicited ARP reply indicates the first logical address maps to the second physical address.

12. The machine-readable medium of claim **11**, wherein the first and second logical addresses comprise the same IP addresses.

13. A redundant computer system comprising:

a processor;

a storage device coupled to the processor, the storage device having stored thereon data representing sequences of instructions, the sequences of instructions, which when executed by a processor, cause said processor to:

receive an indication of a change in status of a primary computer system; and

update an entry in an address translation table on a third computer system on the network by causing a first intermediate computer system to transmit an unsolicited ARP reply to the third computer, wherein prior to

11

being updated the entry mapping a first logical address associated with the primary computer system to a first physical address, after being updated the entry mapping the first logical address to a second physical address.

14. The redundant computer system of claim **13**, wherein the primary computer system is coupled to the network through a second intermediate computer system which acts as an ARP proxy server for the primary computer system, and wherein the first physical address is associated with the second intermediate computer system and the second physical address is associated with the first intermediate computer system.

12

15. The redundant computer system of claim **14**, wherein the first and second physical addresses comprise Ethernet addresses.

16. The redundant computer system of claim **13**, wherein the unsolicited ARP reply indicates the first logical address maps to the second physical address.

17. The redundant computer system of claim **16**, wherein the first and second logical addresses comprise the same IP addresses.

* * * * *